

# Product data sheet

Specifications



## miniature, Harmony Electromechanical Relays, 5A, 2CO, without LED, 24V AC

RXM2LB1B7

Product availability: Stock - Normally stocked in distribution facility

**Price\*: 4.83 USD**

### Main

Range Of Product	Harmony Electromechanical Relays
Series Name	Miniature
Product Or Component Type	Plug-in relay
Device Short Name	RXM
Coil Interference Suppression	Without
Utilisation Coefficient	20 %
Sale Per Indivisible Quantity	10

### Complementary

Contacts Type And Composition	2 C/O
Contact Operation	Standard
[Uc] Control Circuit Voltage	24 V AC 50/60 Hz
[Ithe] Conventional Enclosed Thermal Current	5 A -40...131 °F (-40...55 °C)
Status Led	Without
Control Type	Without push-button
[Ui] Rated Insulation Voltage	250 V IEC
[Uimp] Rated Impulse Withstand Voltage	4 kV 1.2/50 µs IEC 61810-7
Contacts Material	Silver alloy (Ag/Ni)
[Ie] Rated Operational Current	5 A AC-1/DC-1) NO IEC 2.5 A AC-1/DC-1) NC IEC 1 A 28 V DC-13) NO
Minimum Switching Current	10 mA
Maximum Switching Voltage	250 V AC 28 V DC
Minimum Switching Voltage	17 V
Load Current	5 A 250 V AC 5 A 28 V DC
Maximum Switching Capacity	1250 VA AC 140 W DC
Minimum Switching Capacity	170 mW
Operating Rate	<= 1200 cycles/hour under load <= 18000 cycles/hour no-load
Mechanical Durability	10000000 cycles

Price is "List Price" and may be subject to a trade discount – check with your local distributor or retailer for actual price.

<b>Electrical Durability</b>	100000 cycles for resistive load 50000 cycles, 1 A at 28 V, DC-13 NO
<b>Average Coil Consumption In Va</b>	1.2 AC
<b>Drop-Out Voltage Threshold</b>	>= 0.15 U <sub>c</sub> AC
<b>Operating Time</b>	20 ms between coil de-energisation and making of the Off-delay contact 20 ms between coil energisation and making of the On-delay contact
<b>Average Resistance</b>	180 Ohm at 73 °F (23 °C) +/- 10 %
<b>Rated Operational Voltage Limits</b>	19.2...26.4 V AC
<b>Protection Category</b>	RT I
<b>Test Levels</b>	Level A group mounting
<b>Operating Position</b>	Any position
<b>Cad Overall Width</b>	0.83 in (21 mm)
<b>Cad Overall Height</b>	1.06 in (27 mm)
<b>Cad Overall Depth</b>	1.81 in (46 mm)
<b>Net Weight</b>	0.07 lb(US) (0.033 kg)
<b>Dielectric Strength</b>	2000 V AC between coil and contact with basic insulation 2000 V AC between poles with basic insulation 1000 V AC between contacts with micro disconnection
<b>Safety Reliability Data</b>	B10d = 100000

## Environment

<b>Standards</b>	CE IEC 61810-1 (iss. 2)
<b>Ambient Air Temperature For Storage</b>	-40...185 °F (-40...85 °C)
<b>Ambient Air Temperature For Operation</b>	-40...131 °F (-40...55 °C)
<b>Vibration Resistance</b>	3 gn +/- 1 mm 10...50 Hz)operating IEC 60068-2-6 6 gn +/- 1 mm 10...50 Hz)not operating IEC 60068-2-6
<b>Ip Degree Of Protection</b>	IP40 conforming to IEC 60529
<b>Pollution Degree</b>	3
<b>Shock Resistance</b>	30 gnot operating IEC 60068-2-27 10 gnin operation IEC 60068-2-27

## Ordering and shipping details

<b>Category</b>	22153-ATV320/ATV312/ATV32 (10 THRU 30HP)
<b>Discount Schedule</b>	CP4B
<b>Gtin</b>	03389119215176
<b>Returnability</b>	No
<b>Country Of Origin</b>	CN

## Packing Units

<b>Unit Type Of Package 1</b>	PCE
<b>Number Of Units In Package 1</b>	1
<b>Package 1 Height</b>	0.83 in (2.099 cm)
<b>Package 1 Width</b>	1.08 in (2.751 cm)
<b>Package 1 Length</b>	1.81 in (4.596 cm)

<b>Package 1 Weight</b>	1.27 oz (36.0 g)
<b>Unit Type Of Package 2</b>	BB1
<b>Number Of Units In Package 2</b>	10
<b>Package 2 Height</b>	1.18 in (3.0 cm)
<b>Package 2 Width</b>	4.29 in (10.9 cm)
<b>Package 2 Length</b>	5.20 in (13.2 cm)
<b>Package 2 Weight</b>	12.03 oz (341.0 g)
<b>Unit Type Of Package 3</b>	CAR
<b>Number Of Units In Package 3</b>	270
<b>Package 3 Height</b>	5.79 in (14.7 cm)
<b>Package 3 Width</b>	11.81 in (30.0 cm)
<b>Package 3 Length</b>	15.75 in (40.0 cm)
<b>Package 3 Weight</b>	21.30 lb(US) (9.66 kg)

## Contractual warranty

<b>Warranty</b>	18 months
-----------------	-----------

## Sustainability

**Green Premium™** label is Schneider Electric's commitment to delivering products with best-in-class environmental performance. Green Premium promises compliance with the latest regulations, transparency on environmental impacts, as well as circular and low-CO<sub>2</sub> products.

**Guide to assessing product sustainability** is a white paper that clarifies global eco-label standards and how to interpret environmental declarations.

[Learn more about Green Premium >](#)

[Guide to assess a product's sustainability >](#)



Transparency RoHS/REACH

## Well-being performance

✓ Reach Free Of Svhc

✓ Toxic Heavy Metal Free

✓ Mercury Free

✓ Rohs Exemption Information Yes

## Certifications & Standards

**Reach Regulation**

[REACH Declaration](#)

**Eu Rohs Directive**

Pro-active compliance (Product out of EU RoHS legal scope)

[EU RoHS Declaration](#)

**China Rohs Regulation**

[China RoHS declaration](#)

**Environmental Disclosure**

[Product Environmental Profile](#)

**Weee**

The product must be disposed on European Union markets following specific waste collection and never end up in rubbish bins.

**Circularity Profile**

[End of Life Information](#)

**California Proposition 65**

WARNING: This product can expose you to chemicals including: Nickel compounds, which is known to the State of California to cause cancer, and Di-isodecyl phthalate (DIDP), which is known to the State of California to cause birth defects or other reproductive harm. For more information go to [www.P65Warnings.ca.gov](http://www.P65Warnings.ca.gov)

### Dimensions

---

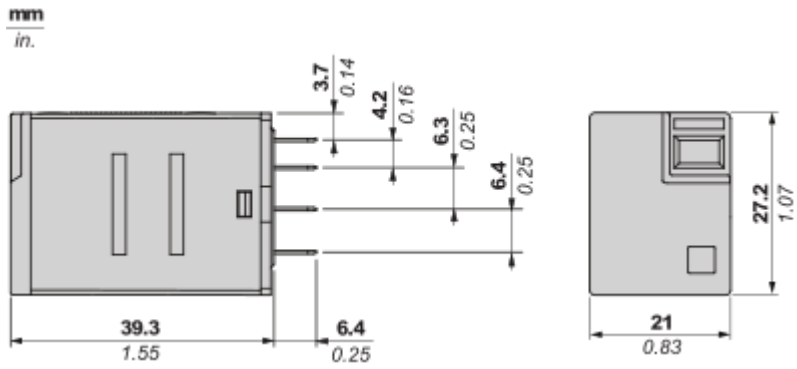

Pin Side View

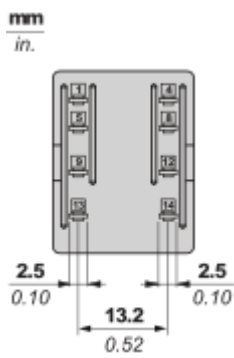

### Wiring Diagram

---

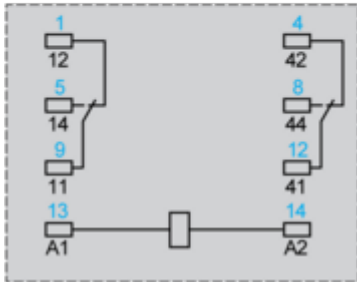
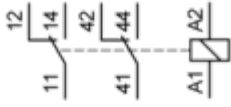

Symbols shown in blue correspond to Nema marking.

Performance Curves

Electrical Durability of Contacts

---

Durability (inductive load) = durability (resistive load) x reduction coefficient.

For 2 Poles Relay

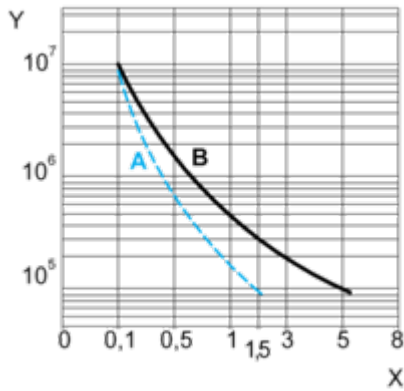

X : Contact current (A)

Y : Durability (Number of operating cycles)

A : Inductive load

B : Resistive load

**Note** : These are typical curves, actual durability depends on load, environment, duty cycle, etc.

For inductive load, to increase relay life cycles, please add a proper load protection circuit (eg: RC protection/Varistor/free Wheeling diode -DC load only- )

**Maximum Switching Capacity**

---

For 2 Poles Relay

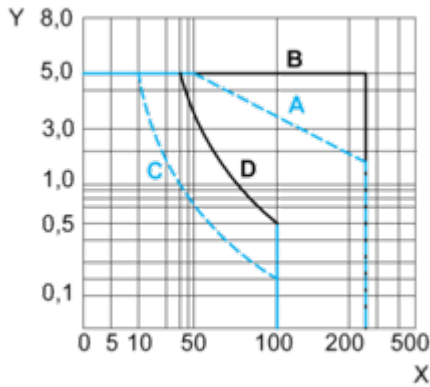

X : Contact voltage (v)

Y : Contact current (A)

A : Inductive AC load

B : Resistive AC load

C : Inductive DC load

D : Resistive DC load

**Note :** These are typical curves, actual durability depends on load, environment, duty cycle, etc.

For inductive load, to increase relay life cycles, please add a proper load protection circuit (eg: RC protection/Varistor/free Wheeling diode -DC load only- )

For low level loads (below 10mA), we recommend to use RXM\*GB series with bifurcated contacts relays instead.



AC Coil Voltage and Operating Temperature under continuous duty

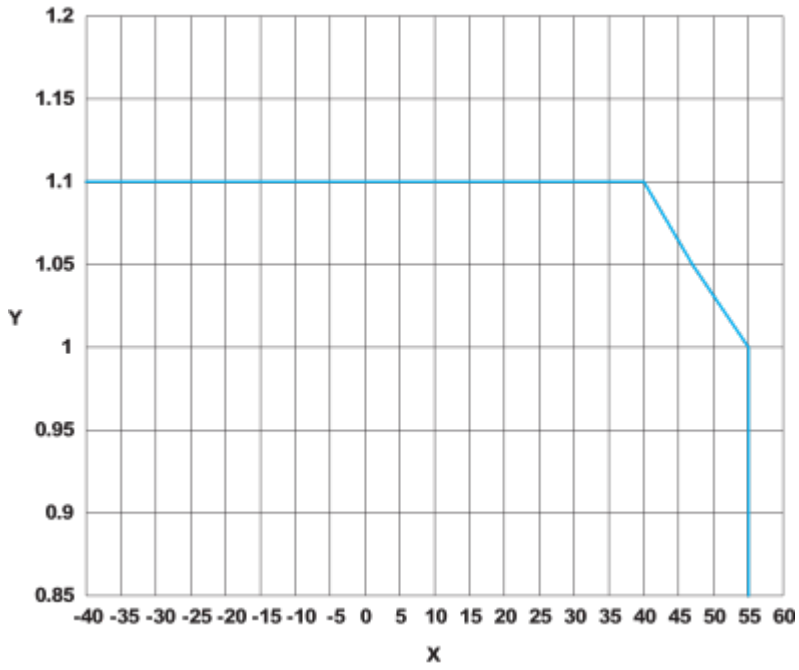

X : Operating temperature (°C)

Y : AC coil voltage (UC)